

DOUBLE GIRDER, MEDIUM, 4 PART SINGLE
Hoist type:
SX5 041...D0

SI-50Hz

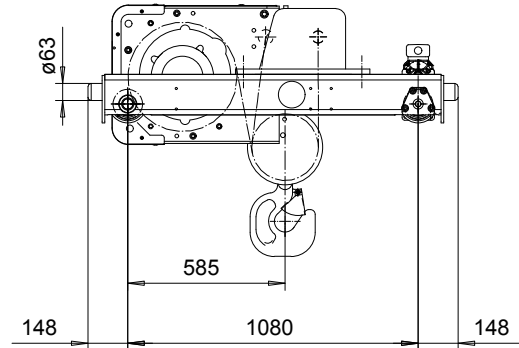
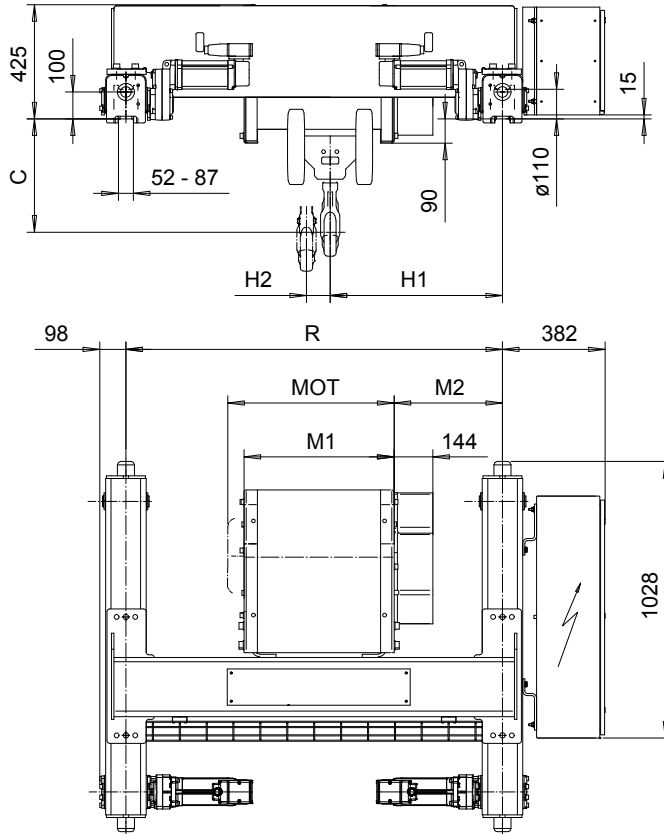

Motor	P5	P6	P7	A5	S5	S7
MOT (mm)	578	578	618	498	606	757
Weight (kg)	58	85	105	45	53	81

HOL	Length	M1	M2	H1	H2	Min R	Approx Weight
(m)	code	(mm)	(mm)	(mm)	(mm)	(mm)	(kg)
9	D	558	403	640	88	1400	670
12	E	678	403	640	118	1400	700
16	F	828	516	753	156	1700	745
20	G	1018	666	903	201	2000	785

Load	Class
(kg)	Fem/ISO
4000	3m/M6
6300	3m/M6
8000	3m/M6
10000	2m/M5

Headroom - C dimension	
Standard	421 mm
with HS22 Hook operated limit switch	471 mm

Note: minR is minimum rail gauge when second brake is supplied
 Standard rail gauges are 1400, 1700, and 2000 mm
 Approx weight calculated with P5 motor

This document is the absolute property of R&M Materials Handling, Inc. This document must not be copied without the written permission of R&M Materials Handling, Inc. The contents thereof must not be disclosed to a third party nor be used for any unauthorized purpose. Contravention will be prosecuted.

ETTPAL Design	ETTPAL Chd	Appd	Ref Drawing	QC-M-04
2002-06-29 Date	TROLLEY; DOUBLE GIRDER			1:12
SLEQDQCV Owner Dept	MEDIUM, 4 ROPE FALLS			Folder
R&M MATERIALS HANDLING INC.	R&M MATERIALS HANDLING, INC. HOIST & CRANE PRODUCTS SPRINGFIELD, OHIO	D002119-A		Issue 10