

DOUBLE GIRDER, HIGH CLEARANCE, 2 PART DOUBLE
Hoist type:
SX5 022...DH

SI-60Hz

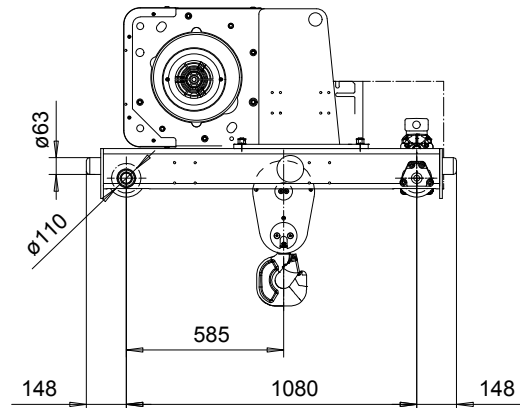
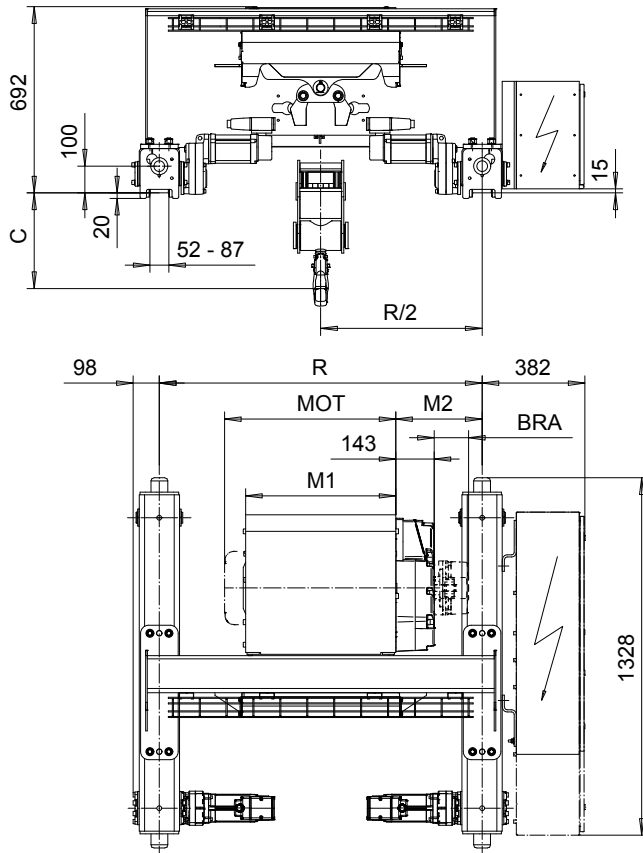

Motor	P5	P6	P7	A5	S5	S7
MOT (mm)	578	578	618	498	606	757
Weight (kg)	58	85	105	45	53	81

HOL (m)	Length code	M1 (mm)	M2 (mm)	BRA (mm)	Min R (mm)	Approx Weight (kg)
8.5	D	558	321	-	1200	675
13	E	678	261	-	1200	695
18	F	828	286	-	1400	735
25	G	1018	341	-	1700	785
33.5	H	1268	216	128	1700	840
46	J	1618	424	128	2400	950

Load (kg)	Class
4000	Fem/ISO
5000	2m/M5

Headroom - C dimension	
Standard	355 mm
with HS22 Hook operated limit switch	405 mm

Note: Brake mounted to gearcase for Length code H & J
 Standard rail gauges are 1200, 1400, 1700, 2000, and 2400 mm
 Approx weight calculated with P5 motor and Min R
 M2 calculated with Min R.

This document is the absolute property of R&M Materials Handling, Inc. This document must not be copied without the written permission of R&M Materials Handling, Inc. The contents thereof must not be disclosed to a third party nor be used for any unauthorized purpose. Contravention will be prosecuted.

ETTPAL Design	ETTPAL Chd	Appd	Ref Drawing	QC-H-22
2002-08-29 Date	TROLLEY; DOUBLE GIRDER			1:12
SLEQDQCV Owner Dept	HIGH, 2x2 ROPE FALLS			Folder
R&M MATERIALS HANDLING INC.	R&M MATERIALS HANDLING, INC HOIST & CRANE PRODUCTS SPRINGFIELD, OHIO	D007182-A		Issue 3