

DOUBLE GIRDER, MEDIUM, 4 PART DOUBLE
Hoist type:
SX5 042...D0

SI-60Hz

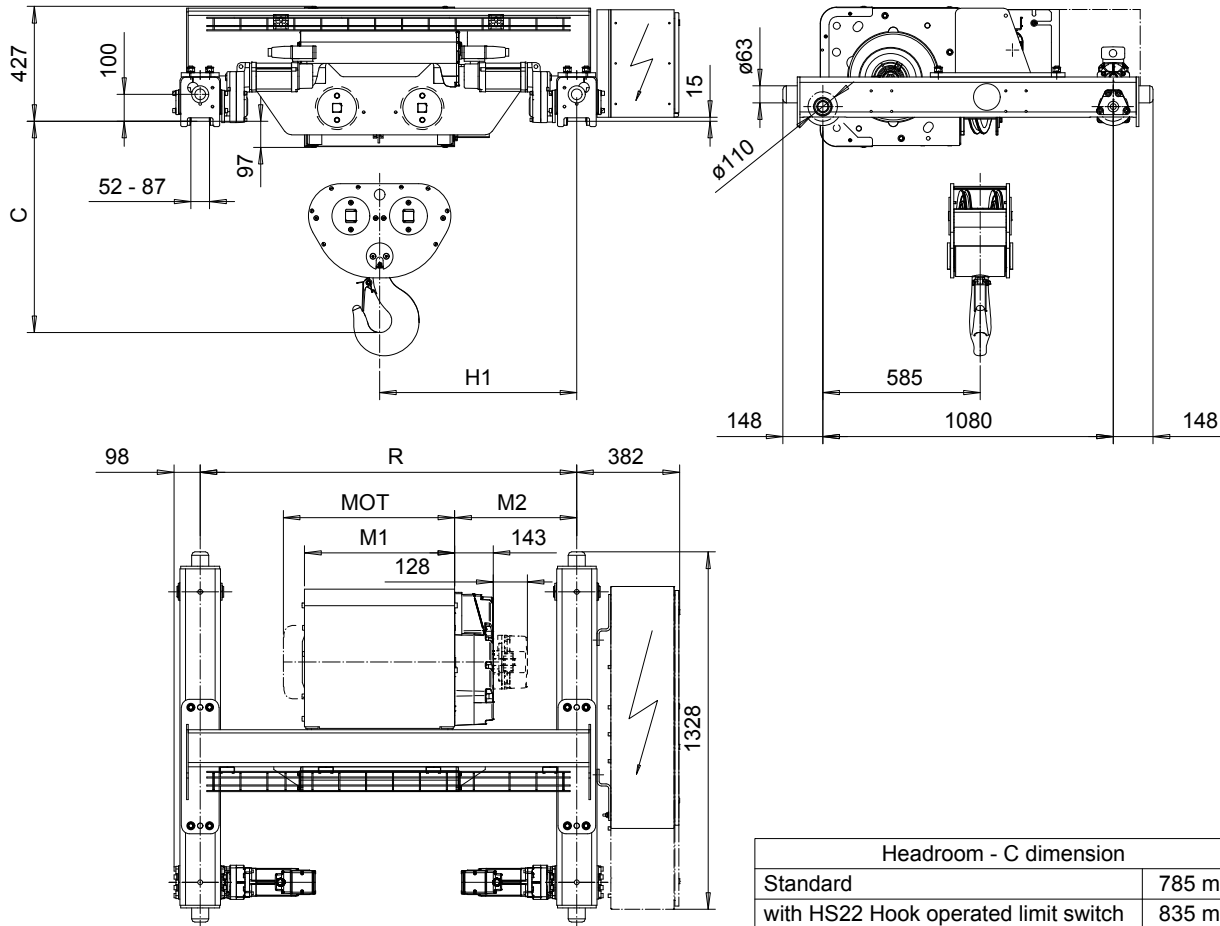

Motor	P5	P6	P7	A5	S5	S7
MOT (mm)	578	578	618	498	606	757
Weight (kg)	58	85	105	45	53	81

Load (kg)	Class Fem/ISO
6300	3m/M6
8000	3m/M6
10000	2m/M5

HOL (m)	Length code	H1 (mm)	M1 (mm)	M2 (mm)	min R (mm)	Approx. Weight (kg)
4	D	733	558	454	1400	725
6.5	E	733	678	394	1400	745
9	F	883	828	469	1700	795
12.5	G	883	1018	374	1700	825
16.5	H	1033	1268	399	2000	900
23	J	1233	1618	424	2400	990

Note:
 R is standard gauge, minimum gauge with second brake or service platform
 Primary brake is mounted on gearcase for drum lengths H and J
 Standard rail gauge increments: 1400, 1700, 2000, and 2400 mm
 Apprx. Weight calculated with P5 motor.

This document is the absolute property of R&M Materials Handling, Inc. This document must not be copied without the written permission of R&M Materials Handling, Inc. The contents thereof must not be disclosed to a third party nor be used for any unauthorized purpose. Contravention will be prosecuted.

ETTPAL	ETTPAL	Appr	Ref Drawing	QC-M-24
Design	TROLLEY; DOUBLE GIRDER			
Date	MEDIUM, 2x4 ROPE FALLS			
SLEQDQCV	Folder			
Owner Dept	Issue			
R&M MATERIALS HANDLING INC.	R&M MATERIALS HANDLING, INC HOIST & CRANE PRODUCTS SPRINGFIELD, OHIO	D007172-A		2