

**DOUBLE GIRDER, MEDIUM, 2 PART DOUBLE**

Hoist type:

SX6 022...D0

SI-60Hz

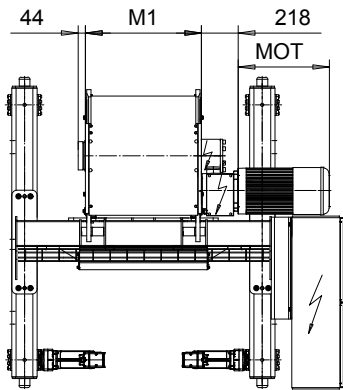
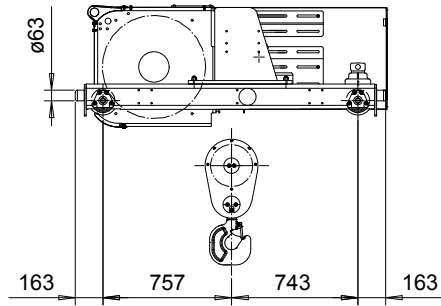
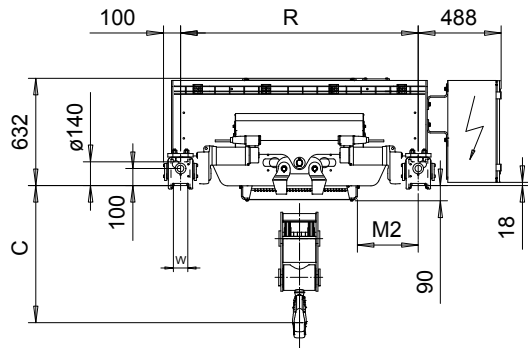

HOL	HOL*	Length	M1	M2	Min R	Max R	Approx Weight
(m)	(m)	code	(mm)	(mm)	(mm)	(mm)	(kg)
15	8.5	E	682	359	1400	2000	1310
21	14.5	F	832	434	1700	2400	1380
28.5	22	G	1022	338	1700	2700	1440
38	31.5	H	1272	364	2000	3100	1560
51.5	45	J	1622	389	2400	3400	1720
63.5	57	K	1922	389	2700	3400	1890
77	70.5	L	2272	414	3100	3400	2090
87	80.5	M	2522	439	3400	3800	2240
98.5	92	N	2822	489	3800	4200	2430

HOL\* with optional drum brake Weight of drum brake is 80 kg.

Motor	P6	P7	P8	A7	S7	S8	SA
MOT (mm)	536	576	711	536	715	763	803
Weight (kg)	85	105	106	71	81	97	120

Load	Class
(kg)	Fem/ISO
6300	3m/M6
8000	2m/M5
10000	1Am/M4

Headroom - C dimension	
Standard	807 mm
with HS22 Hook operated limit switch	857 mm

Standard rail gauges are 1400, 1700, 2000, 2400, 2700, 3100, 3400, 3800, and 4200 mm.

M2 is listed at Min R.

Hoist weight calculated at Min R, with P6 motor, without drum brake.

This document is the absolute property of R&M Materials Handling, Inc. This document must not be copied without the written permission of R&M Materials Handling, Inc. The contents thereof must not be disclosed to a third party nor be used for any unauthorized purpose. Contravention will be prosecuted.

ETTPAL Design	ETTPAL Chd	Appd	Ref Drawing	QD-M-22
2002-09-02 Date	TROLLEY; DOUBLE GIRDER			1:19
SLEODOCV Owner Dept	MEDIUM, 2x2 ROPE FALLS			Folder
R&M MATERIALS HANDLING INC.	R&M MATERIALS HANDLING, INC HOIST & CRANE PRODUCTS SPRINGFIELD, OHIO	D006651-A		Issue 4