

Hoist type:

SXL19 022...R2700

SXL19 042...R2700

SXL19 032...R2700

SXL19 052...R2700

US units

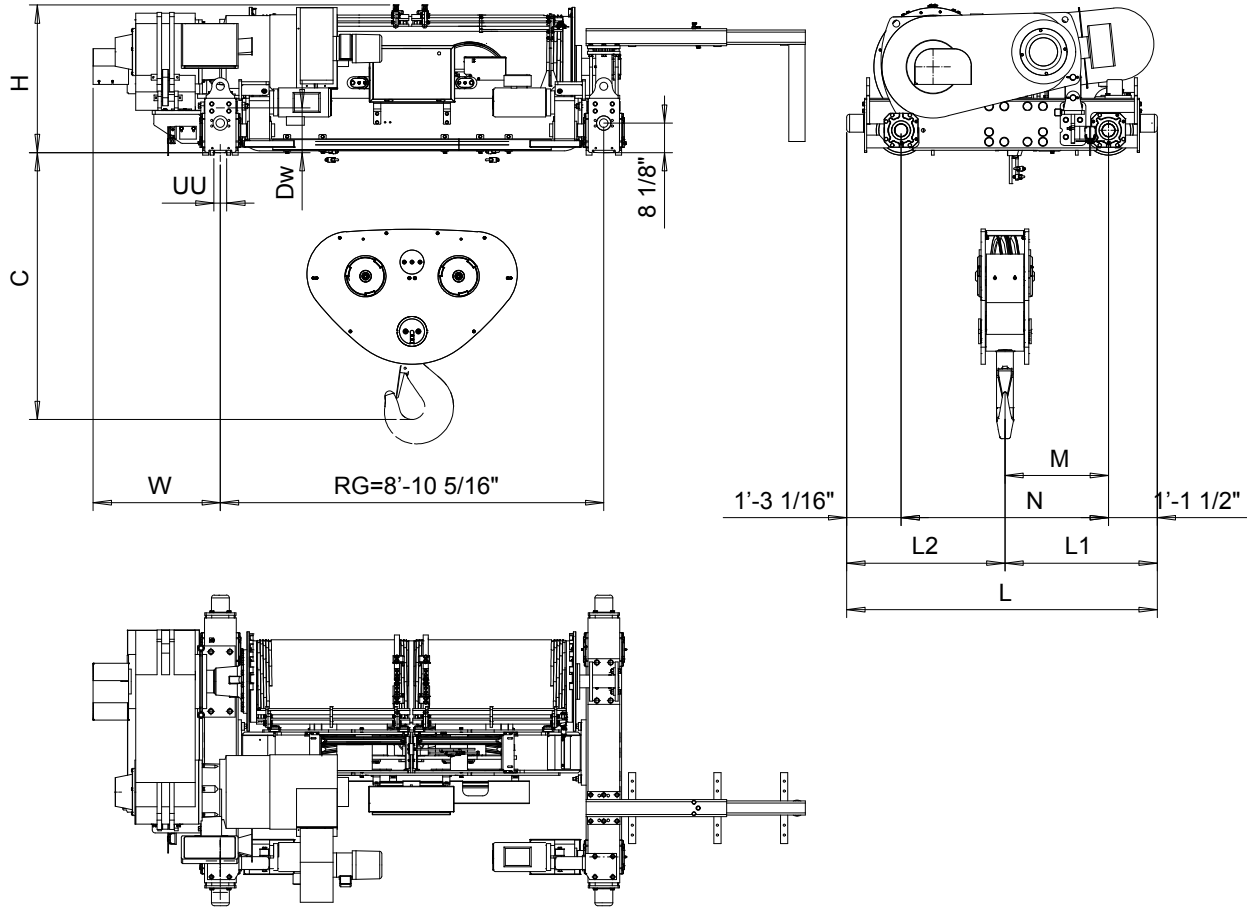

Trolley	Duty 03...06	Hoisting trolley dimensions (inch)							Rail wheel (inch)		C (inch)	Weight (lb)
		H	M	N	L	L1	L2	W	Dw	UU*	(27)	(27)
SXL19022	X	41 3/16"	31 5/16"	57 1/2"	86 1/16"	44 5/8"	41 7/16"	35 5/16"	12.40"	4 1/4"	74 5/8"	16689
SXL19032	X	41 3/16"	30 1/2"	57 1/2"	86 1/16"	43 7/8"	42 3/16"	35 5/16"	12.40"	4 1/4"	74 13/16"	17042
SXL19042	X	41 3/16"	29"	57 1/2"	86 1/16"	42 1/4"	43 13/16"	35 5/16"	12.40"	4 1/4"	73 1/2"	17835
SXL19052	X	41 3/16"	28 9/16"	57 1/2"	86 1/16"	43 3/16"	43 7/8"	35 5/16"	12.40"	4 1/4"	78"	18629

Weight of the service platform is not included into the trolley weight. \*UU based on 4" rail.

DESHPYO Design 2011-06-17 Date				Chd	Appd	Ref Drawing	
TROLLEY; DOUBLE GIRDER				1:25			
SXL19				Folder			
R&M MATERIALS HANDLING INC.				Issue			
R&M MATERIALS HANDLING, INC. HOIST & CRANE PRODUCTS SPRINGFIELD, OHIO				3			
SXL19-R2700-022/032/042/052							
DA002733							

Rev Explanation Date Revised by Checked by

This document is the absolute property of R&M Materials Handling, Inc. This document must not be copied without the written permission of R&M Materials Handling, Inc. The contents thereof must not be disclosed to a third party nor be used for any unauthorized purpose. Contravention will be prosecuted.