

FOOT MOUNT, 2 PART SINGLE
Hoist type:
SX4 021...F0

SI-60Hz

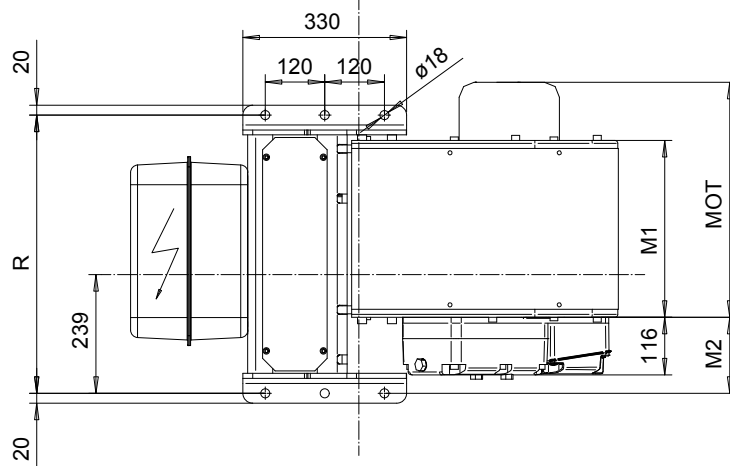
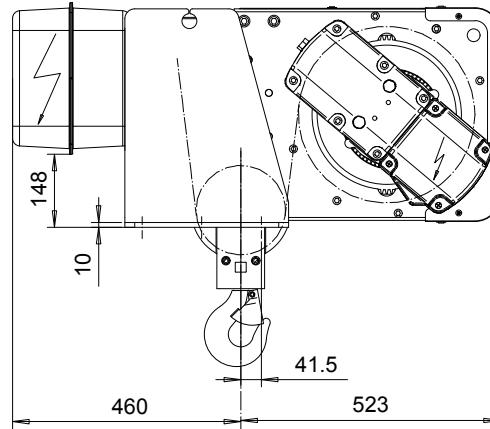
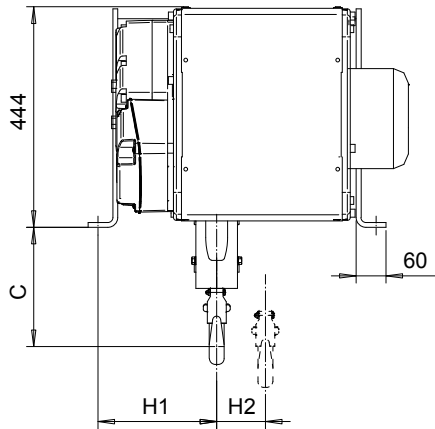

Headroom - C dimension	
Standard	240 mm
with HS22 Hook operated limit switch	470 mm

Motor	P3	P4	A3	S3	S5
MOT (mm)	476	574	446	526	602
Weight (kg)	35	53	32	28	53

HOL	Length	M1	M2	H1	H2	R	Approx Weight
(m)	code	(mm)	(mm)	(mm)	(mm)	(mm)	(kg)
12	B	356	153	239	98	560	195
18	C	456	53	139	147	560	205
24	D	556	53	139	196	780	220
30	E	676	53	139	256	780	240

Load	Class
(kg)	Fem/ISO
1600	3m/M6
2000	3m/M6
2500	2m/M5

Approx. weight calculated with P3 motor.

This document is the absolute property of R&M Materials Handling, Inc. This document must not be copied without the written permission of R&M Materials Handling, Inc. The contents thereof must not be disclosed to a third party nor be used for any unauthorized purpose. Contravention will be prosecuted.

CSDPAL Design	CSDPAL Chd	Appd	Ref Drawing	QB-F-02
2002-08-27 Date	HOIST; FIXED			1:6.5
SLEIENG1 Owner Dept	2 ROPE FALLS			Folder
R&M MATERIALS HANDLING INC.	R&M MATERIALS HANDLING, INC. HOIST & CRANE PRODUCTS SPRINGFIELD, OHIO	D002086-A		Issue 7