

DOUBLE GIRDER, MEDIUM, 4 PART SINGLE

Hoist type:

SX4 041...D0

SI-50Hz

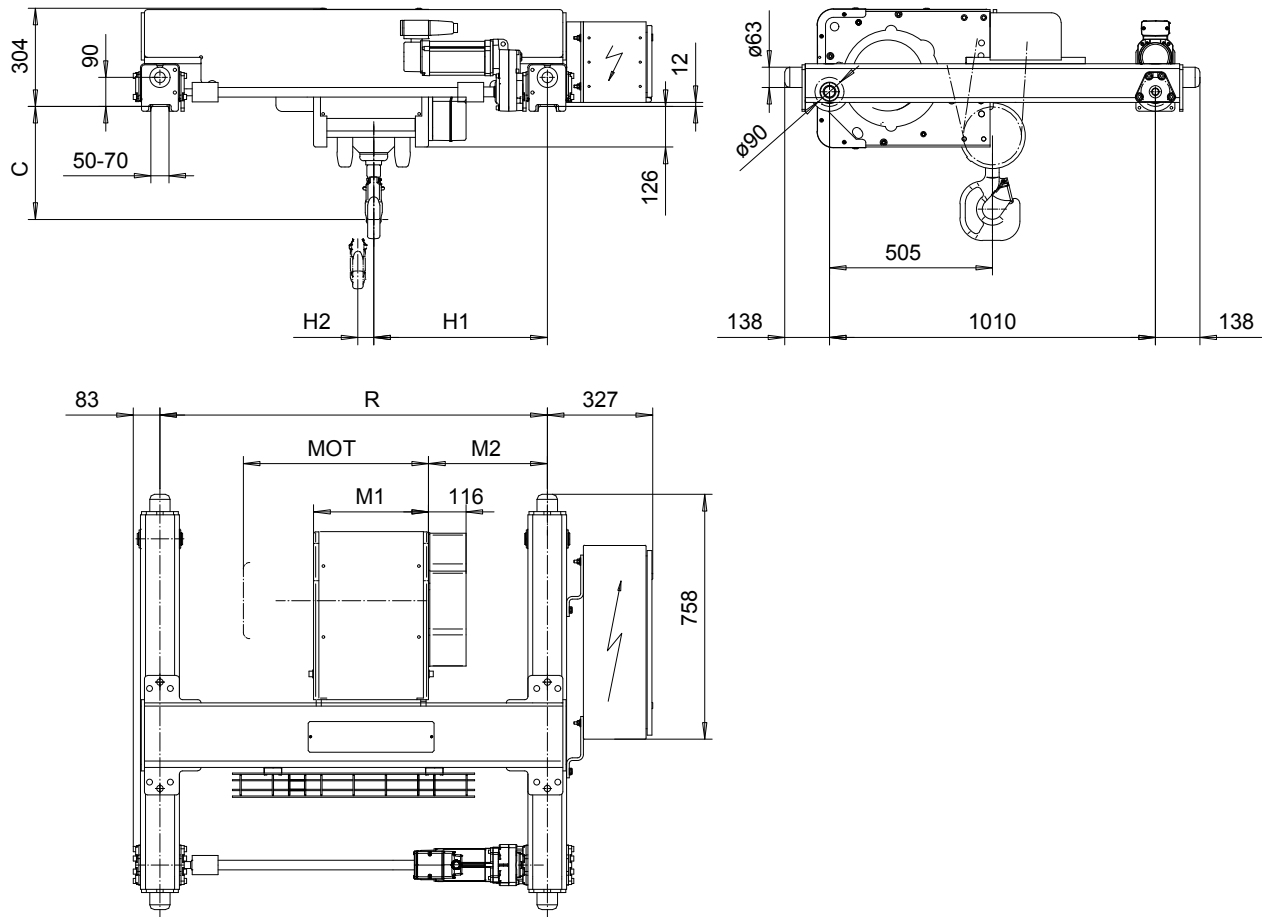

Headroom - C dimension	
Standard	400 mm
with HS22 Hook operated limit switch	490 mm

Motor	P3	P4	A3	S3	S5
MOT (mm)	476	574	446	526	602
Weight (kg)	35	53	32	28	53

HOL	Length	M1	M2	H1	H2	min R	Approx Weight
(m)	code	(mm)	(mm)	(mm)	(mm)	(mm)	(kg)
6	B	356	368	537	49	1200	315
9	C	456	368	537	74	1200	325
12	D	556	468	637	99	1400	340
15	E	676	468	637	129	1400	360

Load	Class
(kg)	Fem/ISO
3200	3m/M6
4000	3m/M6
5000	2m/M5

Note: minR is minimum rail gauge when second brake is supplied
 Standard rail gauges are 1200, 1400, 1700, and 2000 mm
 H1, M2 calculated at minR and weight calculated with P3 motor.

This document is the absolute property of R&M Materials Handling, Inc. This document must not be copied without the written permission of R&M Materials Handling, Inc. The contents thereof must not be disclosed to a third party nor be used for any unauthorized purpose. Contravention will be prosecuted.

Design	Chd	Appd	Ref Drawing	QB-M-04
Date	TROLLEY; DOUBLE GIRDER			1:10 Folder
SLEQENG1 Owner Dept	MEDIUM, 4 ROPE FALLS			
R&M MATERIALS HANDLING INC.	R&M MATERIALS HANDLING, INC. HOIST & CRANE PRODUCTS SPRINGFIELD, OHIO		D002095-A	Issue 9