

DOUBLE GIRDER, HIGH CLEARANCE, 2 PART SINGLE
Hoist type:
SX5 021...DH

US-60Hz

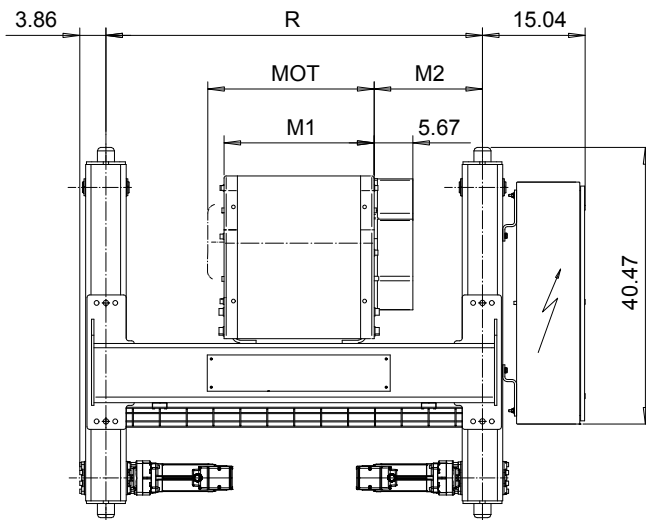
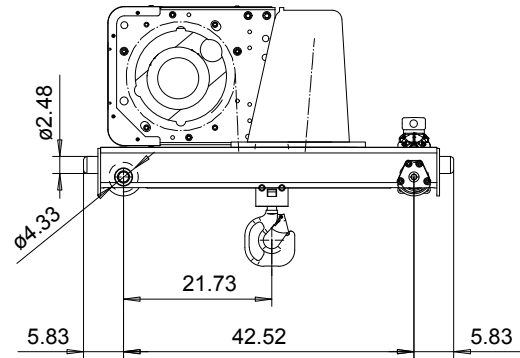
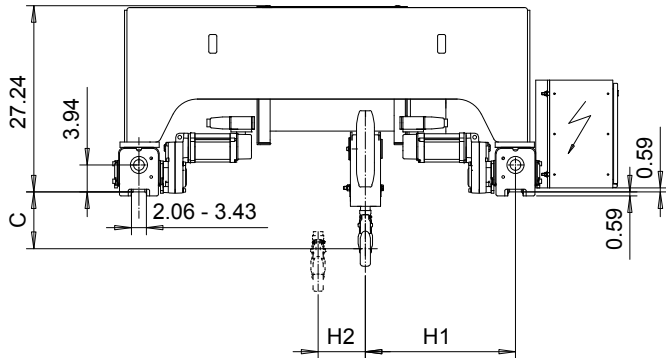

Motor	P5	P6	P7	A5	S5	S7
MOT (in)	22.76	22.76	24.33	19.61	23.86	29.8
Weight (lb)	128	187	231	99	117	179

HOL (ft)	Length code	M1 (inch)	M2 (inch)	H1 (inch)	H2 (inch)	Min R	Approx Weight (lb)
59'-0"	D	21.97	15.87	25.2	6.93"	3'-11 1/4"	1510
78'-8"	E	26.69	15.87	25.2	9.25	3'-11 1/4"	1565
104'-11"	F	32.6	20.31	29.65	12.16	3'-11 1/4"	1620
131'-2"	G	40.08	26.22	35.55	15.87	5'-6 7/8"	1797

Load (ton)	Class
4	H4+
5	H4

Headroom - C dimension	
Standard	9.65"
with HS22 Hook operated limit switch	14.37"

Note: minR is minimum rail gauge when second brake is supplied
 Standard rail gauges are 3'-11 1/4", 4'-7 1/8", 5'-6 7/8", and 6'-6 3/4"
 Approx weight calculated with P5 motor

This document is the absolute property of R&M Materials Handling, Inc. This document must not be copied without the written permission of R&M Materials Handling, Inc. The contents thereof must not be disclosed to a third party nor be used for any unauthorized purpose. Contravention will be prosecuted.

ETTPAL Design	ETTPAL Chd	Appd	Ref Drawing	QC-H-02
2002-06-29 Date	TROLLEY; DOUBLE GIRDER			1:12
SLEQDQCV Owner Dept	HIGH, 2 ROPE FALLS			Folder
R&M MATERIALS HANDLING INC.	R&M MATERIALS HANDLING, INC. HOIST & CRANE PRODUCTS SPRINGFIELD, OHIO	D002238-A		Issue 9