

FOOT MOUNT, 6 PART DOUBLE

Hoist type:

SX7 062...F0

SI-60Hz

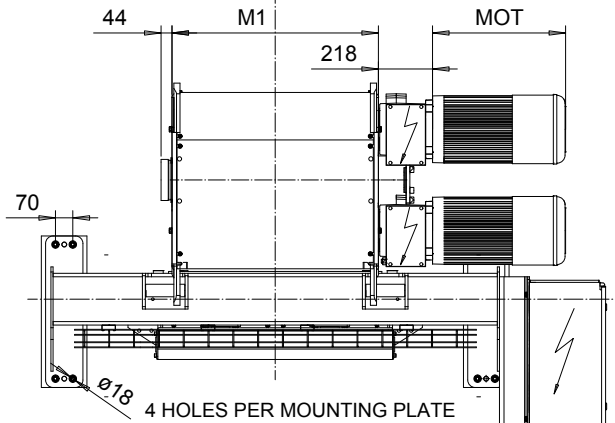
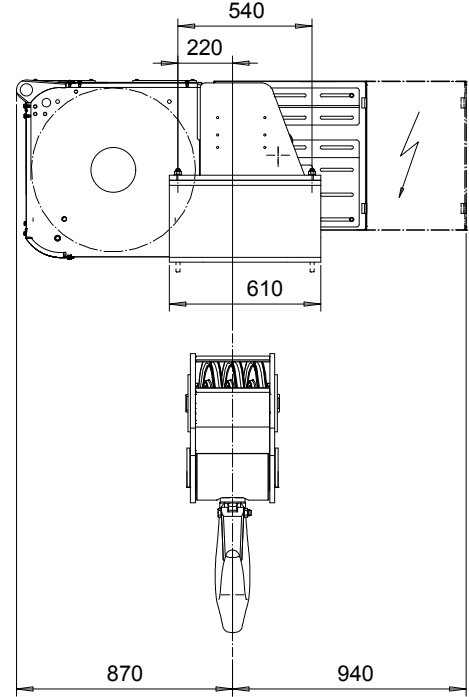
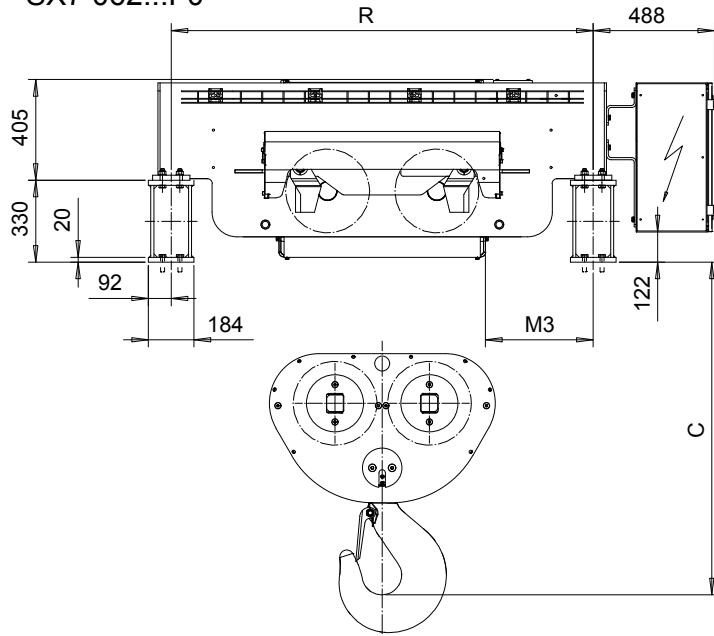

HOL	HOL*	Length code	R	M1	M3	Approx Weight
(m)	(m)		(mm)	(mm)	(mm)	(kg)
5	2.5	F	1700	832	434	1600
6.5	4	G	1700	1022	339	1700
9	6.5	H	2400	1272	565	1900
12.5	10	J	2400	1622	389	2000
15	12.5	K	3100	1922	339	2400
18.5	16	L	3100	2272	414	2600
20.5	18	M	3800	2522	840	3000
23.5	21	N	3800	2822	690	3100

HOL* with optional drum brake Weight of drum brake is 80 kg.

Motor	P6	P7	P8	A7	S7	S8	SA
MOT (mm)	536	576	711	536	715	763	803
Weight (kg)	85	105	106	71	81	97	120

Load (kg)	Class Fem/ISO
40000	3m/M6
50000	2m/M5
60000	1Am/M4

Headroom - C dimension	
Standard	1339 mm
with HS22 Hook operated limit switch	1389 mm

Hoist weight calculated with P6 motor weight and without drum brake.

This document is the absolute property of R&M Materials Handling, Inc. This document must not be copied without the written permission of R&M Materials Handling, Inc. The contents thereof must not be disclosed to a third party nor be used for any unauthorized purpose. Contravention will be prosecuted.

ETTPAL Design	ETTPAL Chd	Appd	Ref Drawing	QE-F-26
2003-01-13 Date	HOIST; FIXED			
SLEODOCV Owner Dept	2X6 ROPE FALLS			
R&M MATERIALS HANDLING INC.	R&M MATERIALS HANDLING INC. HOIST & CRANE PRODUCTS SPRINGFIELD, OHIO	D006946-A		Issue 1/2018